

2X Push ON/OFF Switch Trailing Edge LED dimmer



ATE-VRT100EU

INSTALLATION INSTRUCTION

IMPORTANT !







It is illegal for persons other than an appropriately licensed electrical contractors or other persons authorised by legislation to work on the fixed wiring of any electrical installation.

“This dimmer shall be protected by a 6A or up to a 16A maximum miniature circuit breaker, which is special use with this dimmer.”

WARNING : ELECTRIC SHOCK HAZARD

Hazardous voltage maybe present at the output of the dimmer despite setting the dimmer to zero brightness level. Look out and tag the input circuit before accessing the wiring connections. Failure to follow this warning can result in death or serious injury.

ELECTRICAL SPECIFICATIONS

Parameter	Value
Supply voltage & Frequency	220-240V ~ 50Hz
Rating	2-100W: dimmable LED lamps. 10-100W: incandescent lamps, high voltage halogen lamps and electronic step-down converter for extra low-voltage incandescent lamps.
Compatible loads	   Dimmable LED lighting with compatible Electronic Transformers
	 Incandescent lighting, MV Halogen lamps
	  LV Halogen Lighting with electronic transformers
Operating Temperature	0° - 45°C
Operating Humidity	10 - 90% R.H.
Mounting Centres	82mm EU Pattern Plate

NOTE :
Operation at elevated temperatures or voltages may cause the thermal protection circuit to operate. If this happen, decrease the connected load to prevent re-occurrence.

MINIMUM BRIGHT LEVEL SETTING

How to set the Minimum bright level :



Min. Bright Set Sw1

Minimum bright level set :
Remove front plate cover.
Push ON the lamp, turn Sw1 to set desire min brightness level.

FEATURES :

- Suitable for 1-wayswitching.
- Minimum load down to 2W of capacitive or resistive load, such as Dimmable LED Lighting, Incandescent Lighting, MV Halogen / LV Halogen Lighting with electronic transformers.
- Lamps soft-start operation, to extend longer lifetime for the lamp.
- User setting for the minimum dim Level.
- Complies with IEC EN60669 and International safety standards.

NORMAL OPERATION

Operation of Dimmer Knob and Switch :

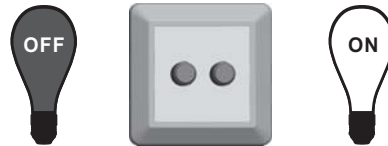

Push knob **ON** or **OFF** the lamp.
Turn knob right to increase brightness to maximum level.
Turn knob left to decrease brightness to minimum level.



INSTALLATION

Wiring Details :

1. Disconnect power. Lock out and tag the relevant circuit at the mains switchboard.
2. Remove existing switch from wall.
3. Connect the dimmer in accordance with the wiring diagrams.
*the copper conductors for the terminals is 1,0 to 1,5mm rigid wire.
4. Refit switch plate to wall and fit the dimmer knob to the shaft.
5. Reconnect power. Push ON and dim with turning knob.

WIRING DIAGRAMS

One Way Operation

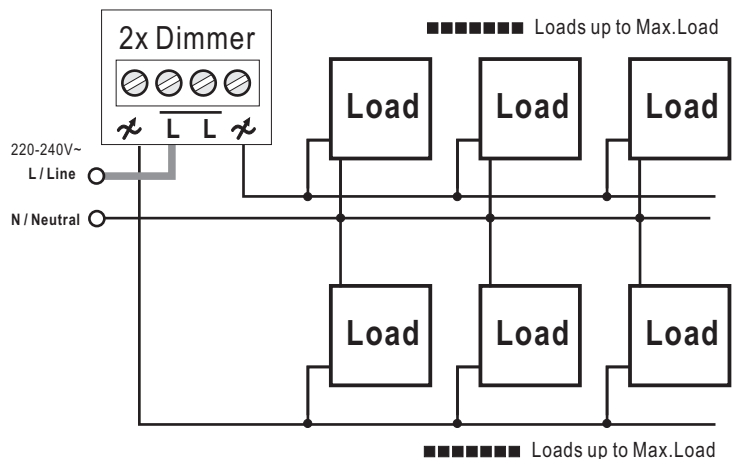

NOTE:
The Dimmer must always be connected to the LINE side of the load.
Two or more dimmers **MUST NOT** be connected in parallel or series to control the same load from two different locations.