

# Auto Detect Intelligent Push ON/OFF 2-way Switch Universal dimmer

Model : ATE-VR250UK - 250W  
Model : ATE-VR400UK - 400W

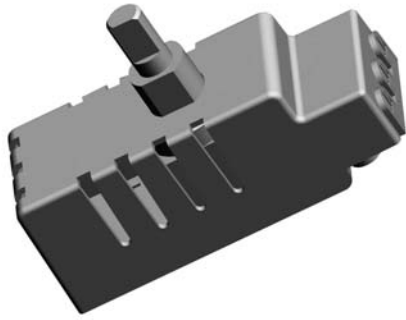

## INSTALLATION INSTRUCTION

### IMPORTANT !







It is illegal for persons other than an appropriately licensed electrical contractors or other persons authorised by legislation to work on the fixed wiring of any electrical installation.

**“This dimmer shall be protected by a 6A or up to a 10A maximum miniature circuit breaker, which is special use with this dimmer.”**

### WARNING : ELECTRIC SHOCK HAZARD

Hazardous voltage maybe present at the output of the dimmer despite setting the dimmer to zero brightness level. Look out and tag the input circuit before accessing the wiring connections. Failure to follow this warning can result in death or serious injury.

### ELECTRICAL SPECIFICATIONS

Parameter	Value
Supply voltage & Frequency	230-240V ~ 50Hz
Maximum Load	250W / 400W , derate for multi-gang installations
Dimming Technology 	Auto Detect Trailing / Leading edge driven control Also, Leading edge dimming mode can be set by user manually.
Compatible loads for TEauto mode	  Dimmable LED lighting with compatible Electronic Transformers
	 Incandescent lighting, MV Halogen lamps
	 LV Halogen Lighting with electronic transformers
Compatible loads for LE mode	 LV Halogen Lighting with Iron-core transformers
<b>*Must be manual change to LE mode</b>	
Operating Temperature	0° - 45°C
Operating Humidity	10 - 90% R.H.
Mounting Centres	In compliance wit BS5733 Pattern Plate
Safety Compliance	BS/EN 60669-2-1 : 2013
EMC Compliance	BS/EN 60669-2-1 : 2002+A1:2008+A2:2015 Excepting when used in conjunction with electronic load

NOTE :  
Operation at elevated temperatures or voltages may cause the thermal protection circuit to operate. If this happen, decrease the connected load to prevent re-occurrence.

### THERMAL OVERLOAD PROTECTION

Build-in thermal protect circuit. Apply a re-settable thermostat component, when module temperature raise achieve 110°C will activate the protection, while temperature cool down approx. 75°C it will become normal operation. If occur frequently, please reduce loading.

### SHORT CIRCUIT PROTECTION

Build-in short circuit protect, once activate, the dimmer will suspend operation around 5 second after that, it will auto-ON again. If detect remain short circuit or over current, the module will suspend operation until disconnect dimmer power and Switch ON dimmer again reset to normal operation. In this case, please check the circuit with electrical technician.

### FEATURES :

- Suitable for 1-way or 2-way switching.
- Minimum load down to 3-5W of capacitive or resistive load, such as Dimmable LED Lighting, Incandescent Lighting, MV Halogen / LV Halogen Lighting with electronic transformers.
- Lamps soft-start operation, to extend longer lifetime for the lamp.
- User setting for the minimum dim Level.
- Build-in short circuit protect, designed to ensure the dimmer can survive in case of wiring fault or catastrophic failure of the load.
- Build-in re-settable thermal cut-off to protect the dimmer over normal operation temperature caused by overloads.
- Complies with BS/IEC safety standards.

### NORMAL OPERATION

Operation of Dimmer Knob and Push Switch :

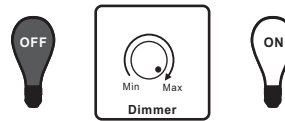

Push knob **ON** or Push knob **OFF** the lamp.  
Turn knob right to increase brightness to maximum level.  
Turn knob left to decrease brightness to minimum level.



### INSTALLATION

Wiring Details :

1. Disconnect power. Lock out and tag the relevant circuit at the mains switchboard.
2. Remove existing switch from wall.
3. Connect the dimmer in accordance with the wiring diagrams.
4. Refit switch plate to wall and fit the dimmer knob to the shaft.
5. Reconnect power. Push ON and dim with turning knob.

### WIRING DIAGRAMS

#### One Way Operation

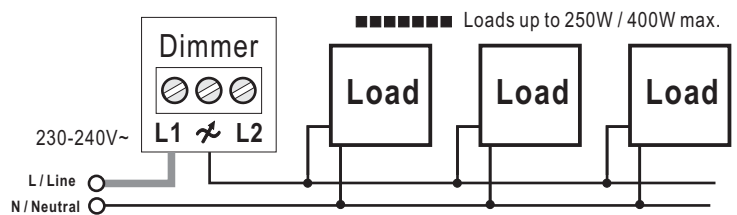

#### Two Way Operation

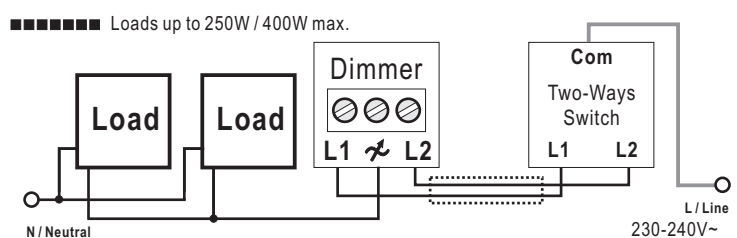

NOTE:  
The Dimmer must always be connected to the LINE side of the load.  
Two or more dimmers **MUST NOT** be connected in parallel or series to control the same load from two different locations.

## MINIMUM BRIGHT LEVEL SETTING

How to set the Minimum bright level :

Operate steps of Dimmer and Switch			Actions
1		Lamp in OFF state, at max position and until around 5 seconds to push ON, and wait lamp stable.	
2		Turn to min position, push OFF and push ON at min. bright.	
3		Turn to max position, push OFF and push ON again, lamp will appear flash 1 time at half-bright level, now is entry minimum Brightness settings.	
4		Set your desire min bright, push OFF and ON for once, lamp will appear at half-bright level then return to normal bright level, it's confirmed and save setting.	

Each step must be performed within 15 seconds, if no, it will time out and auto exit program without save

## COMPATIBLE LOADS

Compatible loads for TEauto mode	
	Integral Dimmable LED lamps
	Dimmable LED lighting with compatible Electronic Transformers
	Incandescent lighting, MV Halogen lamps
	LV Halogen Lighting with Electronic Transformers
Compatible loads for LE mode *Must be manual change to LE mode	
	LV Halogen Lighting with Iron-core Transformers

### NOTE :

When connect with IRON-CORE transformers, only Leading Edge mode (LE) could be applied, the TEauto or TE mode can not be used in this case.

Multiple compatible loads can be used as the total lamp wattage does not exceed the maximum load rating of the dimmer.

Some lamps may exhibit unexpected performance characteristics when cold. Dimming performance should improve after the lamp warms up. Or in case of lamp appears unstable status, it could be changed to LE mode.

## MULTI-GANG DERATING

For applications where Dimmers are multi-ganged, derate the maximum load rating of the unit according to the derating table show as below :

Number of Dimmers	Maximum Load per Dimmer
x1	250W / 400W
x2	220W / 330W
x3	180W / 250W

## MODE SETTING

How to set TEauto, TE or LE Mode (Factory default TEauto mode) :

Operate steps of Dimmer and Switch			Actions
1		Lamp in OFF state, at min position and until around 5 seconds to push ON, and wait lamp stable.	
2		Turn to max position, push OFF and push ON at max bright.	
3		Turn to min position, push OFF and push ON again, lamp will appear flash 4 times at half-bright level, now is entry TEauto / LE mode settings.	
For select TEauto mode (Factory default) *SEE COMPATIBLE LOADS			
TEauto mode		At min position, push OFF and push ON at min bright to confirm and save setting with flash 1 time.	
For select TE mode (for special required*) *SEE COMPATIBLE LOADS			
TE mode		Turn to mid position, push OFF and push ON at mid bright to confirm and save setting with flash 2 times.	
For select LE mode (for special required*) *SEE COMPATIBLE LOADS			
LE mode		Turn to max position, push OFF and push ON at max bright to confirm and save setting with flash 3 times.	

Each step must be performed within 15 seconds, if no, it will time out and auto exit program without save

### NOTE :

: